

CHAMBERLAIN®

LiftMaster®
PROFESSIONAL

The Chamberlain Group, Inc.
845 Larch Avenue
Elmhurst, Illinois 60126-1196
www.liftmaster.com

OWNER'S MANUAL
MODELS

LM21XPBB
LM21XPBBVB

EXTENDED PERFORMANCE RELEASE DEVICE

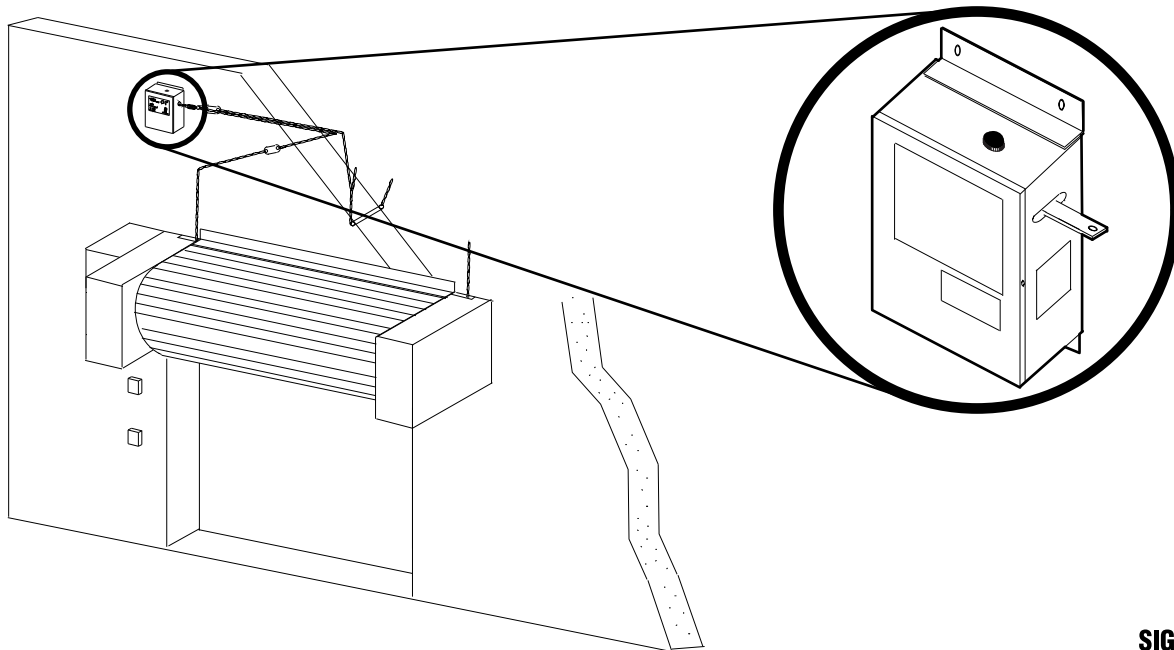

TABLE OF CONTENTS

INTRODUCTION

General Description	2
Agency Requirements	3
Specifications	3
Preparation	3

INSTALLATION

Important Installation Warnings	4
Mount the Release Device	4

WIRING

Wiring Instructions	5
Wire Routing	6
Wiring Diagram	7
Connections of Initiating Devices and Accessories	8-9
Optional Connections	9-10

TESTING

Test Procedures	11
-----------------------	----

TROUBLESHOOTING

Operational Checklist	12
-----------------------------	----

MAINTENANCE

Maintenance Requirements	13
Enclosure Mounted LEDs Status Indicators	13

ACCESSORIES AND REPAIR PARTS

APPENDIX

WARNING

Mechanical

WARNING

Electrical

CAUTION

When you see these Safety Symbols and Signal Words on the following pages, they will alert you to the possibility of **serious injury** or **death** if you do not comply with the warnings that accompany them. The hazard may come from something mechanical or from electric shock. Read the warnings carefully.

When you see this Signal Word on the following pages, it will alert you to the possibility of damage to your door and/or the door operator if you do not comply with the cautionary statements that accompany it. Read them carefully.

IMPORTANT NOTES:

- *BEFORE attempting to install, operate or maintain the release device, you must read and fully understand this manual and follow all safety instructions.*
- *DO NOT attempt repair or service of your release device unless you are an Authorized Service Technician.*

INTRODUCTION

GENERAL DESCRIPTION

The LiftMaster® LM21XPBB and LM21XPBBVB Release Device is UL/ULC listed normally energized fail-safe device designed for use on rolling doors, single-slide and center-parting level and inclined track doors. All models are normally energized fail-safe releasing devices incorporating state-of-the-art electronic control circuitry. The release devices respond to emergency conditions generated from an automatic initiating device and are used in conjunction with a fusible link system.

The release device can be powered from 120Vac, 24 Vac, or 24Vdc. The 24Vdc cannot be sourced from a fire alarm control panel or UL1481 regulated power supply. The devices can be activated via a smoke detector or an alarm relay from the panel's

Form C dry contact relay. The release device features include a 10, 20, 30 or 60 second delay on alarm, closed door detection capabilities, Form C relay outputs for the transmission of alarm and trouble signals transmitted to the fire alarm control panel, an audible trouble sounder, and diagnostic feedback LEDs.

The release device is provided with a battery management system that can provide 24Vdc power for up to four smoke detectors and two horn strobes, as well as provide battery backup for the release device and accessories. As with all releasing device systems, maximum fire protection is provided when installed in accordance with factory specifications and used with a fusible link systems.

INTRODUCTION

AGENCY REQUIREMENTS

Installation and testing to factory specifications shall be performed by factory authorized personnel for proper operation in accordance with the latest National Fire Protection Association (NFPA), Underwriters Laboratories (UL), National Electrical Code (NEC), local, state, county, district and/or other applicable building and fire standards, guidelines, regulations and codes including, but not limited to, all appendices and amendments and the requirements of the local authority having jurisdiction (AHJ).

⚠ WARNING

To prevent possible SERIOUS INJURY or DEATH:

- DO NOT use this device without fusible links installed.
- Test every 90 days to assure proper operation of release device.

SPECIFICATIONS

ELECTRICAL SPECIFICATIONS

VOLTAGE RATING:	120Vac, 60Hz; 24Vac, 60Hz; 24Vdc
STANDBY CURRENT	.06A, .3A, .2A
ALARM CURRENT	.06A, .3A, .25A
BATTERY RATING:	12V 4.5AH Sealed Lead Acid Battery, Maximum charge current .150Amps
BATTERY STANDBY TIME:	LM21XPBB, 72 Hours LM21XPBBVB, 24 Hours

FUSES:	3A @ 250V, 2AG Slo-Blo Type
INITIATING DEVICE:	Maximum line impedance 20 ohm; Maximum current not to exceed .010A.; Maximum voltage 24Vdc
AUXILIARY POWER:	24Vdc @ .5A Maximum
COMMON ALARM AND TROUBLE RELAYS:	.5A 125Vac 60Hz
(MAX. CONTACT RATING)	1A 24Vdc Resistive

MECHANICAL SPECIFICATIONS

LOAD RATING:	Support and Release 40 lbs. Max.
PHYSICAL DIMENSIONS:	9.7" x 7.5" x 5" (h x w x d)

WEIGHT:	Approximately 18 lbs.
(INCLUDING BATTERIES)	

PREPARATION

It is imperative that the wall or mounting surface provide adequate support for the release device.

Refer to the door manufacturer's recommendations for use of this product with specific door being utilized. Use only hardware approved or recognized by the appropriate testing and listing agencies in conjunction with the installation of this product.

Additional items may be required to complete the installation:

- Concrete anchors or fasteners
- Sash chain or 1/16 cable
- Eyebolts-hook
- Fusible links
- Turnbuckles
- Smoke detectors (up to 4 may be installed with this device)

Refer to NFPA 72 and NFPA 80 for instructions concerning proper placement and detection coverage. End-of-line devices shall be installed for supervision of electrical power to 4-wire smoke detector. When using 4-wire smoke detectors with this device, electrical supervision must be provided by means of a UL/ULC listed end-of-line relay.

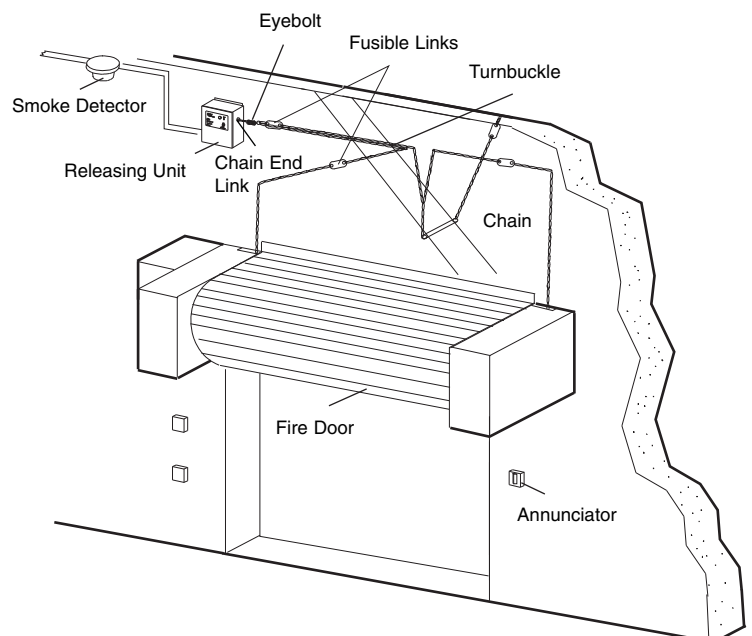

INSTALLATION

IMPORTANT INSTALLATION INSTRUCTIONS

WARNING

To reduce the risk of SEVERE INJURY or DEATH:

1. READ AND FOLLOW ALL INSTALLATION WARNINGS AND INSTRUCTIONS.
2. NEVER connect release device to power source until instructed to do so.
3. DO NOT use this device without fusible links installed.
4. Concrete anchors MUST be used if mounting release device into masonry.
5. DO NOT exceed maximum pull rating of 40 lbs. on releasing device.

Classification:

Releasing device as defined by Underwriters Laboratories.

Installation Requirements:

Intended for "Indoor Dry" locations; all wiring must be performed in accordance with the most current version of NFPA 72 - National Fire Alarm Code and the National Electric Code.

MOUNT THE RELEASE DEVICE

Installation procedures vary according to door types. Refer to door manufacturer's recommendation that applies to your door.

1. Mount the release device on a vertical surface with chain end link exiting side of enclosure.
2. Secure the release device enclosure with fasteners (#10 is the minimum size recommended). If installing in masonry, use concrete anchors (not provided).
3. Install hardware (sash chain or 1/16" cable, eyebolts-hook, fusible links, turnbuckles—not provided) according to door manufacturer's recommendations. **NOTE:** *The end link direction of pull must be perpendicular to the side of the release device enclosure. Install an eyebolt a minimum distance of 12" from the release device to adequately redirect sash chain pull.*
4. Install end link by pressing mechanical reset to allow insertion of end link. Push end link completely in and release mechanical reset to latch end link.
5. Remove sash chain or cable slack by adjusting turnbuckle.

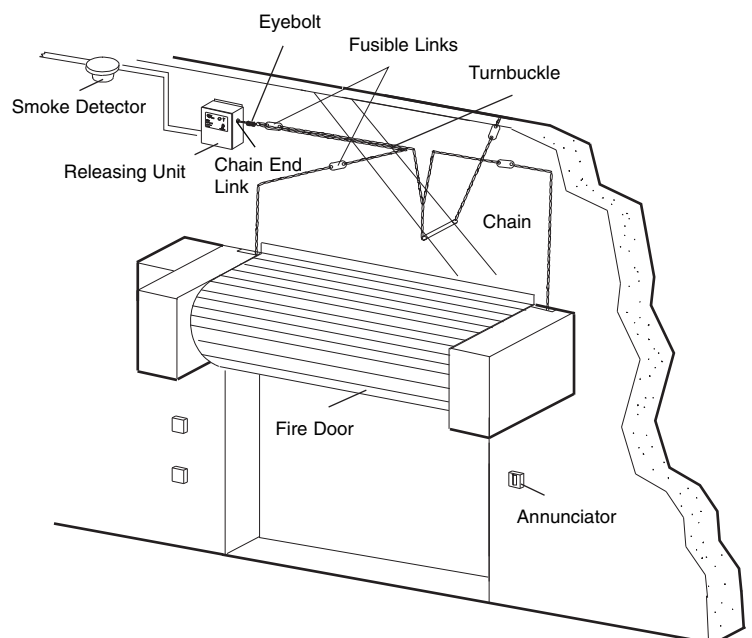
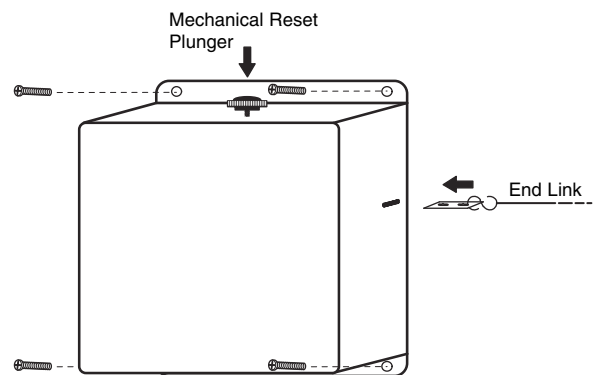

WIRING

WARNING

To reduce the risk of SEVERE INJURY or DEATH:

- ALL electrical connections MUST be made by a qualified individual.
- Disconnect power at the fuse box BEFORE proceeding. Release device MUST be properly grounded and connected in accordance with local electrical codes.
- Installation of ALL wiring and connections, including Class 1 and Class 2 circuits, shall be performed in accordance with, but not limited to, the latest NFPA, UL and N.E.C. standards and codes. In addition, ALL installations subject to Canadian standards shall be performed in accordance with the Canadian Electrical Code, Part I, with respect to wiring material type, wiring gauge related to power capacity requirements and circuit length and wiring methods.
- ALL power wiring should be on a dedicated circuit and well protected. The location of the power disconnect should be visible and clearly labeled.
- ALL power and control wiring MUST be run in separate conduit.
- 120Vac should ONLY be attached to the 3-position terminal block mounted within the enclosure.
- DO NOT disconnect battery or remove battery fuse while unit is under power, the door will drop.

WIRING INSTRUCTIONS

Verify wiring configuration with that recommended by door manufacturer for use of this product with specific door and accessories being utilized. The use of 18 AWG wire is recommended.

1. Close fire door prior to ANY wiring.
2. Turn off power supply sources for the release device as well as the door operator, before beginning.
3. Verify voltage rating of release device to power source being utilized. Voltage is indicated on the side of the unit. Verify that power is disconnected before proceeding.
4. When powering the device from 120Vac line voltage, locate the 3-position terminal block mounted within the device enclosure. Connect 120Vac (single phase) power source inputs to terminals L1 (line) and L2 (neutral) of the terminal block (Figure 1). The third position is used for earth ground.
5. When powering the device from 24Vac or 24Vdc power, connect to terminal board positions 1 and 2 (Figure 2). Observe proper polarity.
6. Do not connect line power or battery until all field wiring is complete per the following pages. The battery provides backup power in the event of a loss of line voltage and prevents the release of the fusible link assembly and the resulting door closure. A pulsing sounder occurs when the battery is disconnected or when replacement is required. The battery also provides power to the various ancillary devices (i.e., smoke detectors, horn/strobes, etc.).

CAUTION

To prevent DAMAGE to the circuit board, ALL connections from terminals 3 through 16 MUST be dry contact type.

FIGURE 1

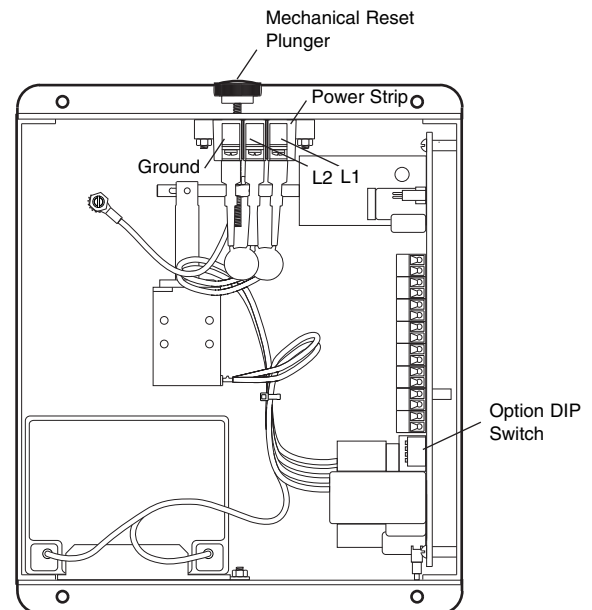
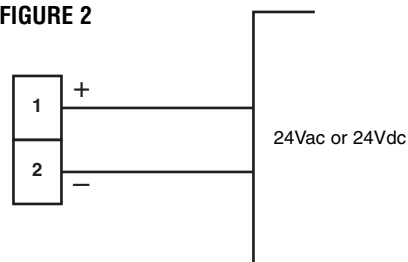
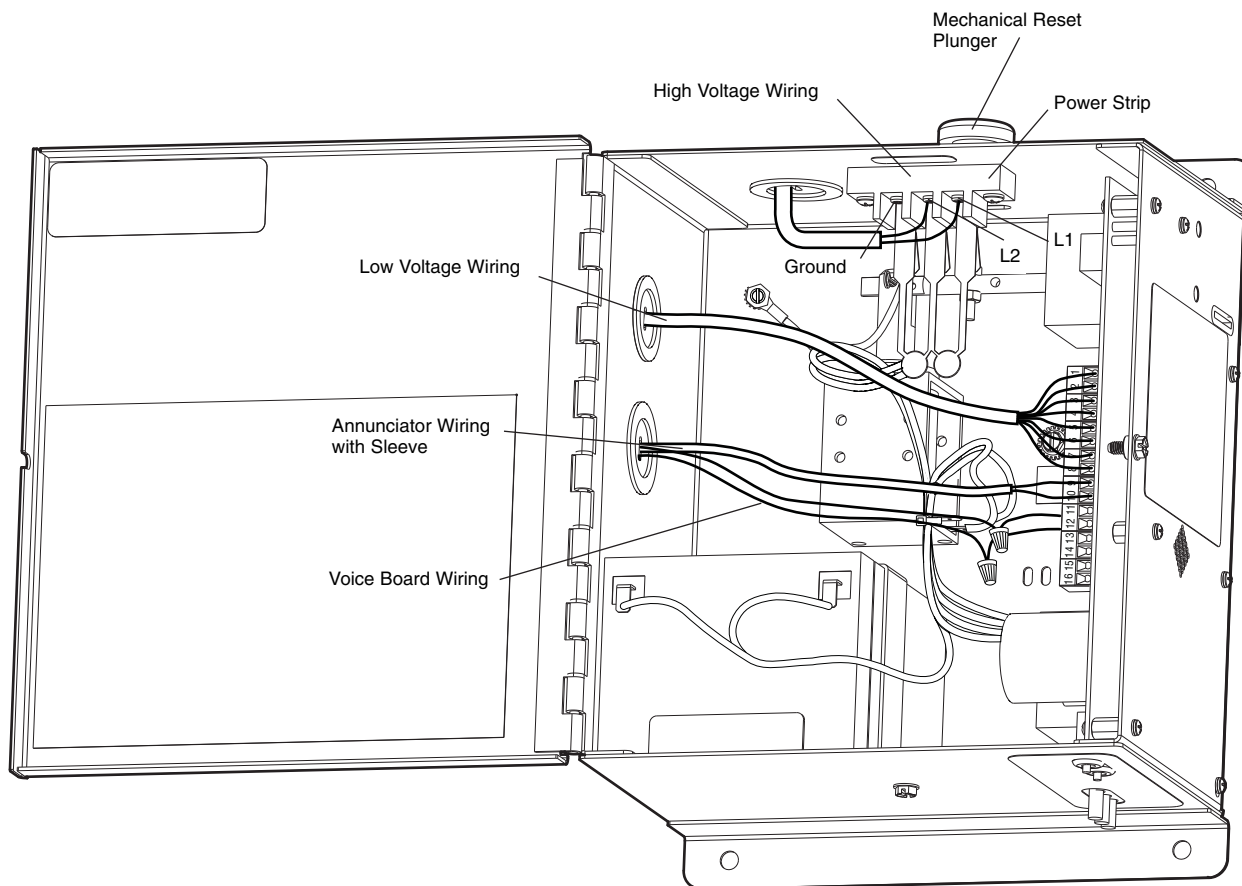

FIGURE 2



WIRING

WIRE ROUTING



PARTS KIT

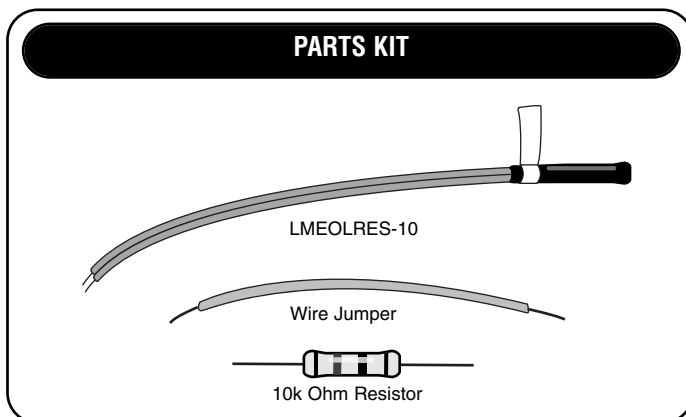

Refer to wiring section for proper application of these parts.

CONNECTIONS OF INITIATING DEVICES AND ACCESSORIES

A maximum of 4 smoke detectors may be installed with this device. Refer to NFPA 72 and NFPA 80 for instructions concerning proper placement and detection coverage. End-of-line devices must be installed for supervision of electrical power to 4-wire smoke detector. When using 4-wire smoke detectors with this device, electrical supervision must be provided by means of a UL/ULC listed end-of-line relay.

NOTE: For low voltage wiring #18 AWG is recommended.

Normally Open "2-Wire," Class B Style A Initiating Devices

Connect wiring from N/O initiating device loop to positions 3 and 4. Place the supervisory resistor (LMEOLRES-10) contained within the accessory pack. (Figure 3). Observe proper polarity, 3 (+), 4 (-) when attaching to the release device's terminal board.

NOTE: Make certain that the Wire Jumper is placed between positions 5 and 6.

This option is a supervised, current-limited circuit.

OR

Normally Open "4-Wire," Class B Style A Initiating Devices

Connect wiring from N/O 4-Wire initiating device loop to positions 3 and 4, making sure an end-of-line supervisory resistor (LMEOLRES-10) is installed as shown in Figure 4 or 5, depending upon the type of smoke detector being used. Observe proper polarity, 3 (+), 4 (-) when attaching to the release device's terminal board.

NOTE: Make certain that the Wire Jumper is placed between positions 5 and 6.

This option is a supervised, current-limited circuit.

OR

Normally Closed "4-Wire," Class B Style A Initiating Devices

Connect wiring from N/C 4-Wire initiating device loop to positions 5 and 6 (Figure 6). This option is a supervised, current-limited circuit.

NOTE: Make certain that the 10k ohm resistor is placed between positions 3 and 4.

NOTE: End-of-line devices must be installed adjacent and after the last initiating device. Initiating device loops are supervised and cannot be direct series or paralleled between multiple release devices or shared with other alarm equipment. For proper wiring configurations from multiple smoke detectors or signaling for simultaneous closure on multiple doors, call technical support, 1-888-528-7870. Incorrect wiring between devices may cause damage to the release control circuit and void warranty.

OR

Relay Module Installation as described on the following page.

⚠ WARNING

To prevent possible **SERIOUS INJURY** or **DEATH**:

- End-of-line devices **MUST** be installed for supervision of electrical power to 4-wire smoke detector.
- **DO NOT** install this device on a motorized door without an electric safety edge.

FIGURE 3

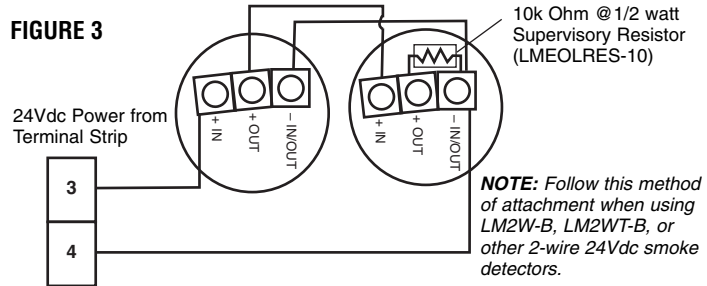

FIGURE 4 **NOTE:** Follow this method of attachment when using LM4W-B, LM4WT-B, or other N/O 4-wire smoke detectors.

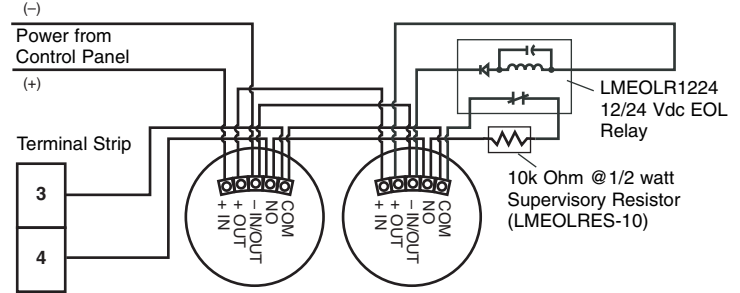

FIGURE 5

NOTE: Follow this method of attachment when using LM4W-B, LM4WT-B, or other N/O 4-wire smoke detectors.

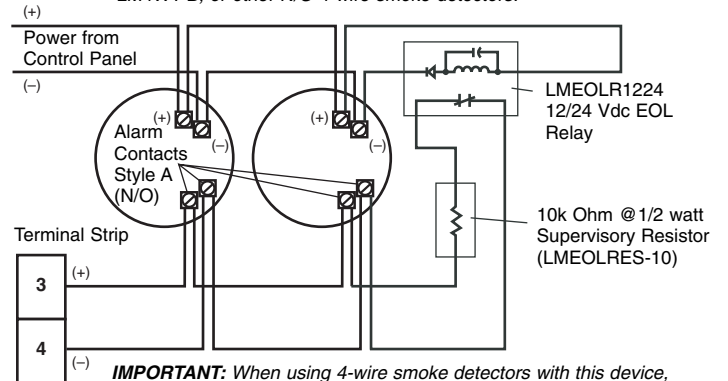
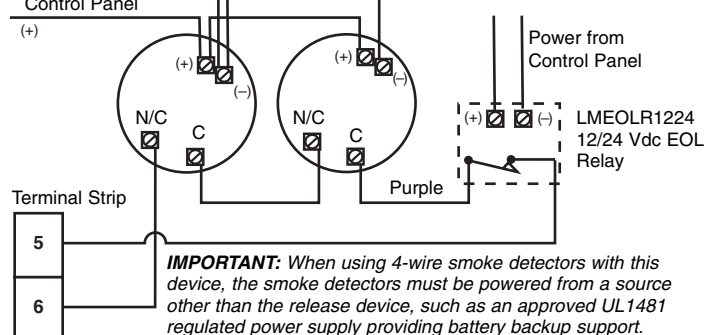

FIGURE 6

NOTE: Generic version of a N/C 4-wire smoke detector is shown.



WIRING

CONNECTIONS OF INITIATING DEVICES AND ACCESSORIES (cont'd)

Relay Module Installation

In lieu of smoke detectors, the release device may be put into alarm by the fire alarm control panel. Most commonly, a relay module is used as an interface between the fire alarm control panel and the release device. The relay module must provide Form C dry contacts for connection to the appropriate terminals on the release device (Figure 7).

NOTE: When choosing a relay module to activate the release device in an alarm condition, always select one that provides Form C dry contact relays. Do not use any relay module providing or passing any (control) voltage through the contacts into the release device. The passage of voltage through such a relay module into the release device will cause problems with the operation of the device and may damage the device's terminals and/or circuit board. Make certain that the 10k ohm resistor is placed between positions 3 and 4.

OPTIONAL CONNECTIONS

CLOSE DOOR DETECTION OPTION

Connect wiring from N/O electrical loop, using a proximity switch or other similar device with dry contacts, to 7 and 8 (Figure 8). The switch should be placed to engage when the door is in the closed position and so that it will toggle states from its N/O condition (switch closed when door is closed) to a closed condition indicating that the door edge has made contact with desired down position. When the switch is closed by contact from the door, the release device will not activate on alarm, thereby eliminating nuisance gravity drops through the inadvertent release of the fusible link assembly. This option only works as long as power is available to unit. Fail-safe operation is maintained under all operating conditions, and if power is not available to the unit, the fusible link assembly will be released. This is a power-limited, unsupervised circuit. This proximity switch must be mounted in the same room as the release device.

RELAY AND TROUBLE OUTPUTS OPTION

Connect wiring from the Alarm Relay Outputs (#11 N/C or #13 N/O and #12 Common) to the appropriate inputs on the Fire Alarm Control Panel to provide a signal at the panel when the release device is in an alarm state. Connect wiring from the Trouble Relay Outputs (#14 N/C or #16 N/O and #15 Common) to the appropriate inputs on the Fire Alarm Control Panel to provide a signal at the panel that the release device is in a trouble state (Figure 9). If these features are desired, coordinate the interconnection between the Release Device and the Fire Alarm Control Panel with the fire alarm installer.

ANNUNCIATOR OPTION

To power one or two (maximum) horn/strobes or similar annunciators, connect wiring to terminals 9 and 10 (Figure 10). Route wires through the non-conductive sleeving (provided) covering any exposed bare wires. Maximum distance of wire run within conduit not to exceed 20' total. This is a supervised, non power-limited circuit.

NOTE: If installing two visual annunciators, they must be installed on opposite sides of wall. If unused, place 10k Ohm Resistor between positions 9 and 10.

CAUTION

To prevent DAMAGE to the circuit board, ALL connections from terminals 3 through 16 MUST be dry contact type.

FIGURE 7

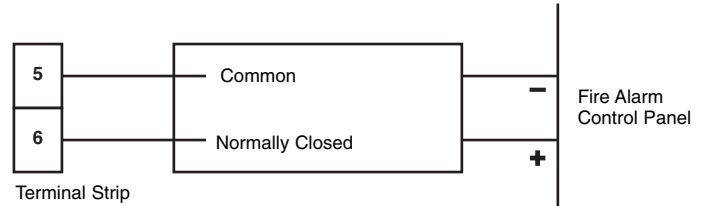

FIGURE 8

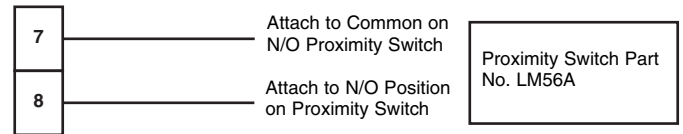

FIGURE 9

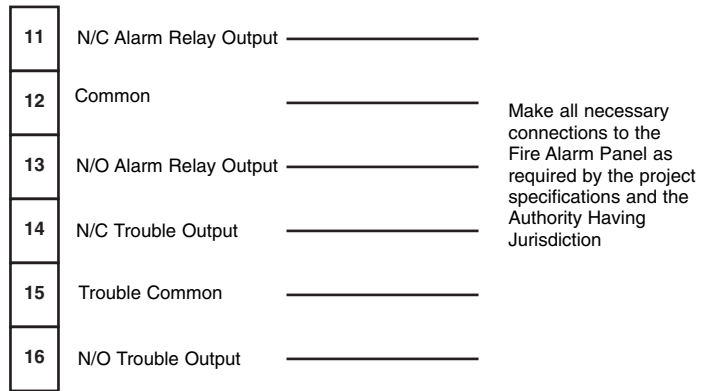
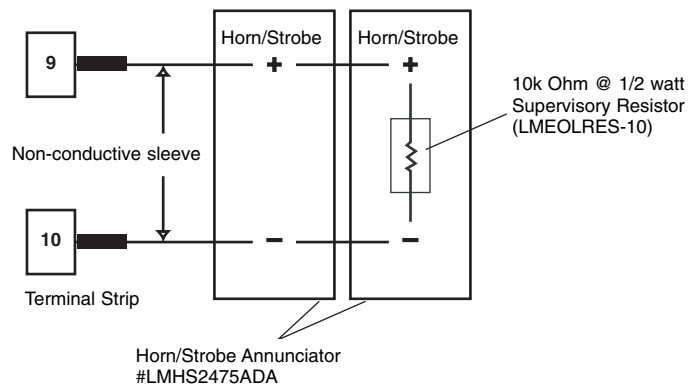

FIGURE 10

NOTE: A maximum of two annunciators may be installed in this manner.



WIRING

OPTIONAL CONNECTIONS (cont'd)

VOICE BOARD OPTION

The voice board provides one of two verbal warnings that the fire door is closing. Typically, depending on the length of the delay chosen on the release device, a warning tone will occur prior to the message, which is approximately 10 seconds in length (for example, a 20 second delay setting on the release device will result in a 10 second warning tone followed by the verbal warning message). There are two messages that may be selected:

Message 1: Warning tone followed by the message, "Warning! An emergency condition exists and this fire door is about to close; please remove any obstructions from its path and stand clear."

Message 2: Warning tone followed by the message, "Warning! This fire door will close in 10 seconds... 5 seconds... the fire door is now closing; please remove any obstructions from its path and stand clear."

The release device has an 4-position DIP Switch mounted on the circuit board, and the switch at position #3 permits selection of either message. In the "ON" position, Message 1 is activated; in the "OFF" position, Message 2 is activated (Figure 12).

The voice board can drive up to two 70.7V speakers (Model LM8SP) or speaker inputs to speaker strobes (Model LMPSTR2475ADA). Maximum delivered power is 5 watts.

A potentiometer (VR1) is mounted on the board and rotation counterclockwise increases the volume (clockwise to decrease volume) (Figure 11).

DIP SWITCH SELECTION

The release device will provide a factory default delay of 10 seconds (to minimize nuisance alarms) before releasing the fusible link chain upon alarm or power loss. A 4-position DIP Switch found on the PC board within the release device can be used to adjust the length of the delay to one of four preset delays. The optional delay settings are as follows:

Delay Setting	Switch Position	
	1	2
10 Seconds	Off	Off
20 Seconds	Off	On
30 Seconds	On	Off
60 Seconds	On	On

NOTE: Set all DIP switch options before applying power to the system.

FIGURE 11

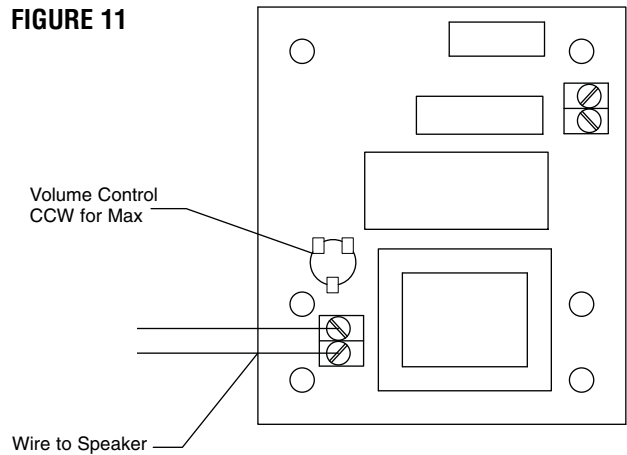
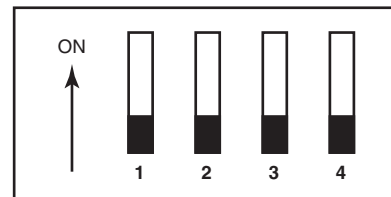

FIGURE 12

NOTE: Position 4 is unused and should remain in the OFF position. Position 3 is used to select one of the two available voice messages.



Factory default setting of 10 seconds shown.

TESTING

TEST PROCEDURES

TO BE PERFORMED BY FACTORY AUTHORIZED PERSONNEL ONLY! CLEAR FIRE DOOR OPENING AND PROHIBIT TRAFFIC THROUGH DOOR OPENING WHILE TESTING!

Testing does not affect normal operation of alarm system when connected to release device/control panel. Testing of the release device is independent of, and shall in no way be interpreted as an alternative method of, testing of a central fire alarm system, motorized operator and/or any other system component employed on the fire door or counter fire door installation. Complete testing and normal operation can only be accomplished with power applied to unit.

Door must be in open position with power applied to unit to begin testing. The following procedures describe testing of all options. Verify options ordered and installed with unit. All tests may not apply. Refer to Figure 13 for location of all the LEDs and switches mentioned in this section.

INITIAL POWER UP

1. Connect black battery wire to the black terminal on the battery. Connect the red battery wire to the red terminal.
2. Apply line power to the unit.
3. Power LED (red) and battery LED (green) will be lit on the bottom of the release device (Figure 13).

MECHANICAL RELEASE

1. Depress and continue to hold test button on side of release device. Unit will beep as delay expires. After the selected delay expires, the device will release the end link and allow door to drop. Release test button.
2. Reset the door per door manufacturer's instructions. Raise door and then reset the release device by pushing downward on the mechanical reset button at the top of the device. Fully insert the end link through the side opening on the device and release the reset button in order to latch end link.

CLOSE DOOR DETECTION (OPTIONAL)

1. Using the chain hoist or motor operator, lower the door to fully closed position.
2. Verify that Release Disabled LED (yellow) is lit indicating door closure. Depress and continue to hold test button on side of release device for 10 seconds. Close Door Detection logic will prohibit the release device from energizing and releasing the end link. Reset the test button (Figure 13).
3. Raise door to fully open position.

SUSPENSION OF POWER

1. Make sure door is in fully open position. Turn off all power to release device and disconnect battery. Immediately upon loss of power (line voltage and battery backup) to the release device, a mechanical release will be initiated.
2. Reset the door per door manufacturer's instructions. Raise the door and then reset the release device by pushing downward on the Mechanical Reset Plunger at the top of the device. Fully insert the end link through the side opening on the device and release the Mechanical Reset Plunger in order to latch end link. Press the "Reset" button on the device to reset the alarm loop.

⚠ WARNING

To prevent possible SERIOUS INJURY or DEATH:

- Clear fire door opening and prohibit ALL traffic through door opening while testing.
- Test every 90 days to assure proper operation of release device.

FIGURE 13

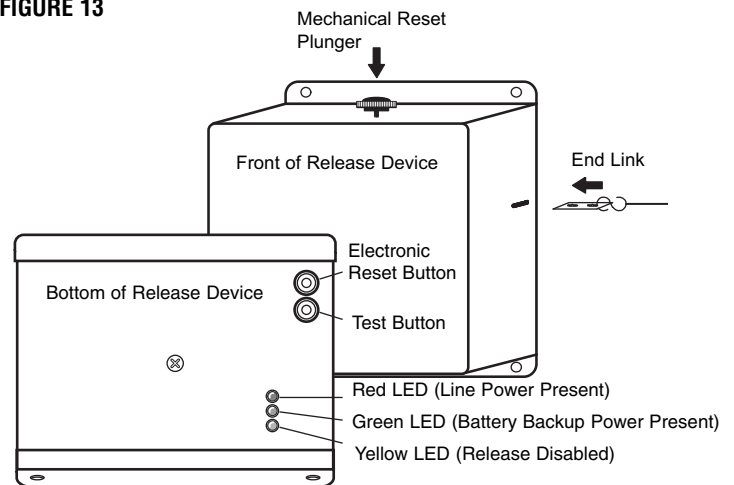

After completing all tests, make sure the door is in its normal position (open or closed) and all power required for normal operation is restored to unit. The release device is designed to operate with power applied.

NOTE: Testing shall be performed and witnessed for proper operation.

TROUBLESHOOTING

OPERATIONAL CHECKLIST

POWER

Is the red LED, labeled “Power,” located on the bottom of the enclosure lit?

Is the Red LED Lit?	
Yes	Move on.
No	Check power connections per Wiring Diagram.
	Check voltage; voltage should be 120Vac, 24Vac or 24Vdc connected as part of the wiring diagram.

CHECK THE ALARM

Are the alarm (smoke detection) inputs correct? If not, the release device will not release the fusible link assembly in a fire condition. Conversely, the release device will always release the fusible link assembly when powered or reset.

Are the Alarm Inputs correct?	
Yes	Move on.
No	Check that it is a dry contact input. There should not be any voltage on the alarm lines when they are disconnected from the unit.
	Verify that all wiring is per manufacturers’ instructions.

CIRCUIT BOARD DIAGNOSTIC LEDs

View diagnostic LEDs present on the circuit board located behind the terminal block (See Wiring Diagram). Refer to the table below for the status LED indications.

LED	LED Color	Description
N/O Detector Trouble	Yellow (LED 6)	If lit, indicates a trouble condition (open) within the N/O 2-wire (or 4-wire) smoke detector loop (emanating from terminal board positions 3 and 4), resulting from either incorrect wiring or incorrect placement of the end-of-line resistor, and the smoke detector loop is inactive. Refer to the Smoke Detector Installation section of this manual for correct wiring instructions (Figures 3-5).
N/O Detector Alarm	Red (LED 5)	If lit, indicates that the N/O 2-wire (or 4-wire) smoke detector loop (emanating from terminal board positions 3 and 4) is in alarm. When lit during testing, press the Auxiliary Reset Button at the bottom of the release device to reset the loop (Figures 3-5).
N/C Detector Trouble	Red (LED 4)	If lit, indicates an open circuit within the N/C 4-wire smoke detector loop (emanating from terminal board positions 5 and 6), resulting from either incorrect wiring or incorrect placement of the end-of-line relay or the detector(s) are in alarm. If in alarm, cycle power off and then on to the smoke detectors to reset, then depress the auxiliary reset button to reset the release device. Refer to the Smoke Detector Installation section of this manual for correct wiring instructions (Figures 6 and 7).
Close Door Detection	Green (LED 2)	If lit, indicates that the fire door or shutter is closed and activating the proximity switch. If not lit, refer to the Close Door Detection section of this manual for correct wiring instructions (Figure 8).
Annunciator Trouble	Yellow (LED 9)	If lit, indicates a trouble condition (open) within the annunciator loop (emanating from terminal board positions 9 and 10), resulting from either incorrect wiring or incorrect placement of the end-of-line resistor. Refer to the Annunciator section of this manual for correct wiring instructions (Figure 10).
Ground Fault	Yellow (LED 3)	If lit, indicates that one of the ancillary devices/loops (smoke detector, annunciator, etc.) is not grounded properly, and a short to earth ground exists.

WARNING

To prevent possible SERIOUS INJURY or DEATH:

- Clear fire door opening and prohibit ALL traffic through door opening while trouble shooting.

CHECK THE CLOSE DOOR DETECTION

Is the Yellow LED on the bottom of the enclosure lit? If lit, the close limit detection input is active, the device is disabled and will not perform a mechanical release.

CHECK THE BATTERY CONNECTIONS

Is the Green LED on the bottom of the enclosure lit? If so, the battery is connected properly. If the LED does not light, the battery is not functioning properly and a trouble sounder will annunciate. Check the following:

1. Are the battery leads properly connected or do the leads have a defective connector?
2. Do the battery connections observe correct polarity — Red (+) and Black (–)?
3. Is the battery discharged? If so, allow 10 minutes for the battery management system to recharge the battery. If the sounder does not stop after this time, then the battery needs to be replaced. Refer to the “Replacement Parts and Accessories” section of this manual for ordering instructions.

Battery Performance Inconsistencies - Does the unit go into alarm and release the fusible link as soon as power is applied? If so, then check the wiring and connections on the smoke detector loop, focusing especially on the presence and the correct placement of the end-of-line resistor. Also, if N/O smoke detectors are being used, make certain that the Wire Jumper between positions 5 and 6 on the release device’s terminal strip is in place.

MAINTENANCE

MAINTENANCE REQUIREMENTS

The release device has no scheduled maintenance requirements. The unit has been designed and tested for use in dry, indoor locations. Testing of the unit at least once every 90 days is recommended, but test intervals shall ultimately be subject to criteria established by the Authority Having Jurisdiction (AHJ).

FUSE REPLACEMENT PROCEDURE AND REPAIR PARTS

One serviceable fuse, a 3 Amp, 3AG, slo-blo fuse, is required for proper operation and protection of the circuit board. The release device is shipped with the fuse in place and two replacement fuses are provided in a separate parts bag. The fuse is located on the circuit board near the battery cable connection.

For replacement parts refer to Accessory and Replacement Parts page.

BATTERY MAINTENANCE/TESTING

No maintenance or testing is required for the battery. An audible warning tone, generated by the trouble annunciator mounted to the side of the release device, will sound when the battery is approaching the minimum operating threshold. This indicates the need to replace the battery.

For replacement parts refer to Accessory and Replacement Parts page.

BATTERY DISPOSAL

Spent batteries must be treated as hazardous waste and disposed of in accordance with State, Local and Federal Regulations.

ENCLOSURE MOUNTED LEDS STATUS INDICATORS

LED Label	LED Color	Description	Action Required
Battery	Green	If the Green LED is lit, then the battery is connected properly and charged above the minimum acceptable level.	If the LED does not light, check that the leads are connected to the battery as shown on the wiring diagram.
Disable	Yellow	The Yellow LED will light when the door reaches the close limit and activates a proximity switch attached to terminal positions 7 and 8 on the release device. This configuration results in the device not releasing the fusible link assembly in alarm or power loss situations and should only be used when the fire door is kept in a constant closed position.	If the LED does not light when the door reaches the close door detection and activates the proximity switch, then check that the proximity switch has been activated and that the switch is set to normally open (N.O.). Check to make certain that the switch is attached to terminal positions 7 and 8 on the release device.
Power	Red	If the Red LED is lit, then the line power is connected and switched "on."	If the LED does not light when power is applied, check that power is connected as described in the installation manual electrical connections.

WARNING

To avoid SERIOUS PERSONAL INJURY or DEATH:

- Stand clear of path of door.
- Disconnect ALL electrical and battery power BEFORE performing maintenance.

FIGURE 14

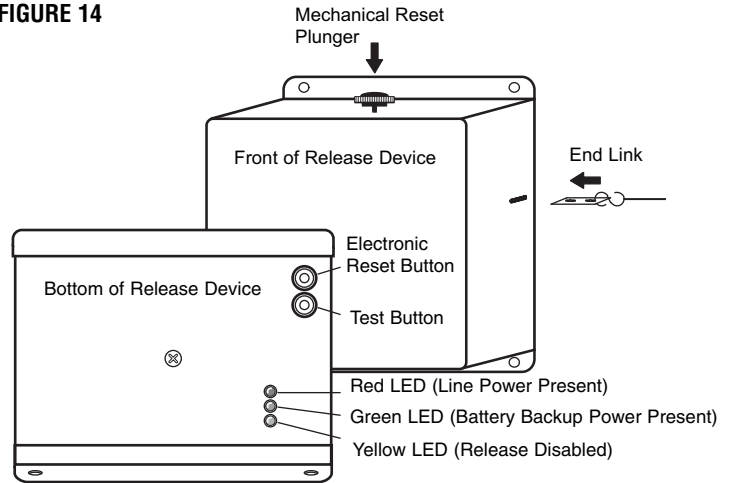

ACCESSORIES AND REPLACEMENT PARTS

ACCESSORIES

ITEM	PART #	DESCRIPTION	ITEM	PART #	DESCRIPTION
1	LM8100	Smoke Detector - 120V Photo	12	LMEH1224ADA	Horn - 12/24Vdc
2	LM8100T	Smoke Detector - 120V Photo with Thermal	13	LMPSTR2475ADA	Speaker Strobe - 24Vdc
3	LM8100I	Smoke Detector - 120V Ion	14	LML2475ADA	Strobe - 24Vdc
4	LM2WB	Smoke Detector - 12/24Vdc 2-Wire Photo	15	LMHS2475ADA	Horn/Strobe - 24Vdc
5	LM2WTB	Smoke Detector - 12/24Vdc 2-Wire Photo with Thermal	16	LMEH1224ADA	Horn - 24Vdc
6	LM4WB	Smoke Detector - 12/24Vdc 4-Wire Photo	17	LMPSTR1V75ADA	Speaker Strobe - 120Vac
7	LM4WTB	Smoke Detector - 12/24Vdc 4-Wire Photo with Thermal and Form C Relay	18	LML1V750ADA	Strobe - 120Vac
8	LM1424	Smoke Detector - 24Vdc Ion	19	LMHS1V75ADA	Horn/Strobe - 120Vac
9	LM1412	Smoke Detector - 12Vdc Ion	20	LMEH120ADA	Horn - 120Vac
10	LMTH135	Heat Detector - 135 Degree Fixed Temperature	21	LM8SP	Speaker 8"
11	LMTH194	Heat Detector - 194 Degree Fixed Temperature	22	LMEOLR1224	End-of-Line Relay - 12/24Vdc
			23	LMEOLR120	End-of-Line Relay - 120Vac

REPLACEMENT PARTS

ITEM	PART #	DESCRIPTION
1	LMRK	Reset Knob
2	LMELH	End Link
3	LM2AG3AMP	Fuse - 3Amp
4	LMEOLRES10	End-of-Line Resistor, 10 kOhm
5	LM4AH12	Battery

NOTE: Certain accessories above will require a separate power source. Refer to product manual.

HOW TO ORDER REPAIR PARTS

OUR LARGE SERVICE ORGANIZATION SPANS AMERICA

Installation and service information
call our TOLL FREE number:

1-800-528-2806

APPENDIX

ACCESSORY COMPATIBILITY GUIDE

SMOKE DETECTORS

MODEL NO.	DESCRIPTION	SYSTEM SENSOR MODEL NO.	
LM2WB	24Vdc 2-Wire Photo	2W-B	
LM2WTB	24Vdc 2-Wire Photo with Thermal	2WT-B	
LM4WB	24Vdc 4-Wire Photo	4W-B	
LM4WTB	24Vdc 4-Wire Photo with Thermal & Form C Relay	4WT-B	
LM1424	24Vdc Ion	#1424	

HEAT DETECTORS

MODEL NO.	DESCRIPTION	SYSTEM SENSOR MODEL NO.	CHEMTRONICS MODEL NO.	EDWARDS SYSTEM TECHNOLOGY (EST) MODEL NO.
LMTH135	135 Degree Fixed Temperature	#5603	#603	#283B-PL
LMTH194	194 Degree Fixed Temperature	#5604	#604	#284B-PL

NOTIFICATION DEVICES

MODEL NO.	DESCRIPTION	SYSTEM SENSOR MODEL NO.	
LMPSTR2475ADA	24Vdc Speaker Strobe	SP2R1224MC	
LML2475ADA	24Vdc Strobe	S1224MC	
LMHS2475ADA	24Vdc Horn/Strobe	P1224MC, P2R	
LMEH1224ADA	24Vdc Horn	H12/24	
LM8SP	Speaker	SP201R	

END-OF-LINE DEVICE

MODEL NO.	DESCRIPTION	SYSTEM SENSOR MODEL NO.	SPACE AGE ELECTRONICS NO.	LIFTMASTER NO.
LMEOLRES10	10 kOhm End-of-Line Resistor			LMEOLRES-10
LMEOLR1224	End-of-Line Relay	EOLR-1		
LMEOLR120	End-of-Line Relay		PAM-1	

NOTE: Certain accessories above will require a separate power source. Refer to product manual.

